



Power Break® II Circuit Breaker Accessories

Mechanical Interlock for Stationary Breakers, 800–2000 A Frames

Introduction

The Mechanical Interlock accessory, catalog number SPWB20 and shown in Figure 1, can be installed in 800–2000 ampere frame Power Break® II stationary circuit breakers. When two breakers in adjacent compartments are connected with an interlock rod, shown in Figure 2, this accessory prevents the simultaneous closing of both breakers. When either breaker is ON, the other will immediately trip if an attempt is made to turn it ON.

When both breakers are OFF, either breaker may be turned ON. However, when one breaker is ON, an attempt to close the second breaker causes its closing springs to discharge without moving the contact arms.

An override feature is provided in case of a race condition (both breakers turned ON simultaneously from OFF), so that the breaker designated as primary turns ON and the secondary breaker trips.

Either or both circuit breakers may be CHARGED at any time, but the interlock operation activates only when one of the breakers is ON.

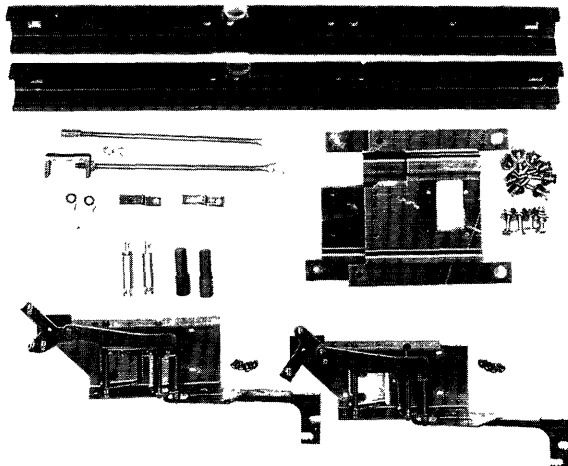

Figure 1. Mechanical Interlock accessory components

Horizontal or Vertical Connection

The interlocked breakers can be mounted and connected either vertically (one breaker above the other) or horizontally (breakers mounted side by side). The connecting rod can be installed in either of two positions for the desired action. All end connectors are provided, so the customer need only supply a 1/4-20 threaded rod of the appropriate length.

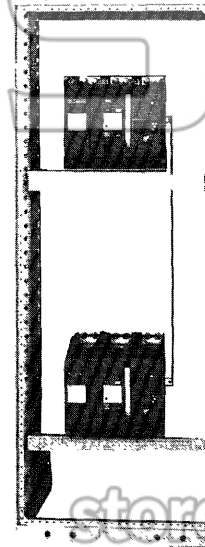

Figure 2. Mechanical Interlock attached to Power Break II circuit breakers in a switchboard.

Installation

WARNING: Before installing any accessories, turn the breaker off, disconnect it from all voltage sources, and discharge the closing springs.

AVERTISSEMENT: Avant d'installer tout accessoire, mettre le disjoncteur en position OFF, le déconnecter de toute tension d'alimentation, et décharger les ressorts d'armement.

Breaker Unit

The primary breaker unit has a solid operating link and the secondary breaker unit has a spring-loaded override link. In the event of a race condition, in which both breakers are turned ON simultaneously while both are OFF, the primary unit turns ON and the secondary unit trips. The primary unit must be installed on the top or right breaker so that the rod connecting the breakers operates in a "pull" condition.

Use the following procedure to install the interlock units on each circuit breaker.

1. Install the threaded trip plunger into the square hole on the rear of the breaker, as shown in Figure 3. Tighten to 8 in-lb.

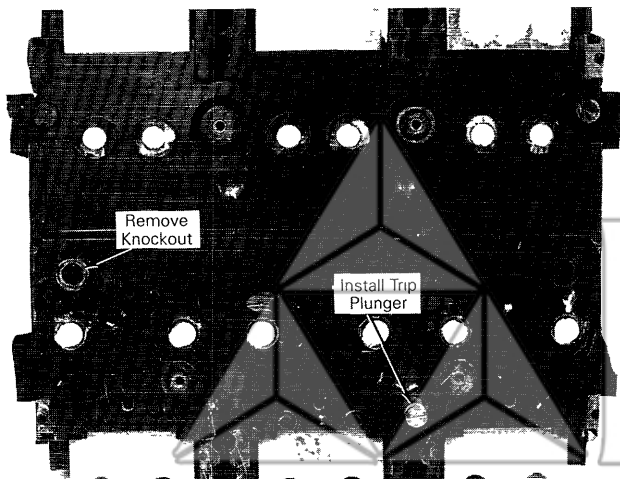

Figure 3. Trip plunger installed in the rear of the breaker.

2. Remove the knockout on the rear of the breaker, as shown in Figure 3. Be sure to clean the edges of the hole, so that the interlock plunger can move freely in and out.
3. Install the interlock plunger in the hole made in step 2, as illustrated in Figure 4.

NOTE: Two aluminum support bars are supplied for mounting with clearance for the trip plunger. If alternate mounting is required, make sure that clearance for the trip plunger is provided and that the base plate is $\frac{3}{8}$ " from the breaker.

NOTE: Deux tiges de soutien en aluminium sont fournies pour l'assemblage, avec un espace pour le piston du déclencheur. Si un autre assemblage est nécessaire, assurez-vous que l'espace pour le piston du déclencheur est suffisant et que la base de la plaque est à $\frac{3}{8}$ " du disjoncteur.

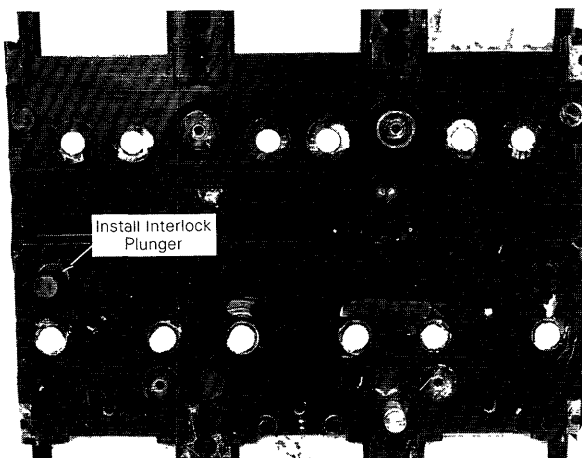

Figure 4. Interlock plunger installed in the breaker..

4. Mount the two U-shaped channels to the rear of the breaker with two $\frac{1}{4}$ -20 hex-head screws, flat washers, and lock washers each, as shown in Figure 5. Do not tighten the screws at this point. Position the cutout in the lower channel over the trip plunger.
5. Install the baseplate over the channels, using the left channel mounting screws and two additional $\frac{1}{4}$ -20 hex-head screws, nuts, flat and lock washers, as shown in Figure 5. Tighten all screws to 20 in-lb.

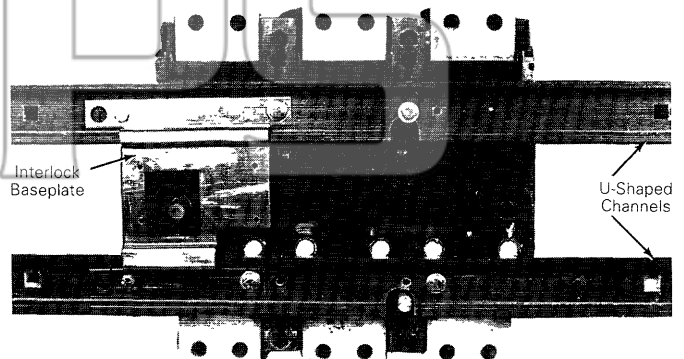

Figure 5. U-shaped channels and interlock baseplate installed on the rear of the breaker.

6. Install the interlock mechanism, as shown in Figure 6, hooking the trip lever over the slot in the trip plunger. The hole in the underside of the mechanism must line up with the interlock plunger. Attach with four #10-32 Philips-head screws and tighten to 15 in-lb.
7. Close the breaker and check that the T-lever on the interlock mechanism rotates. Open the breaker to return the T-lever to its starting position. Rotate the T-lever in the opposite direction and check that the trip plunger is pulled out.

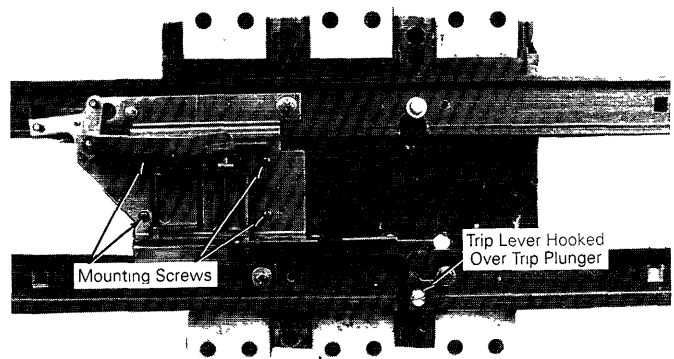

Figure 6. Interlock mechanism attached to the breaker.

Vertical Interconnection

Use the following procedure to install the interconnect components between two breakers installed one above the other.

1. Attach the rod ends to the pivots as shown in Figure 7. The rod ends are provided in the Mechanical Interlock kit; the $\frac{1}{4}$ -20 threaded rod is supplied by the customer.
2. Adjust the length of the rod so that the pivot-to-pivot distance is equal to the distance between the two compartments.

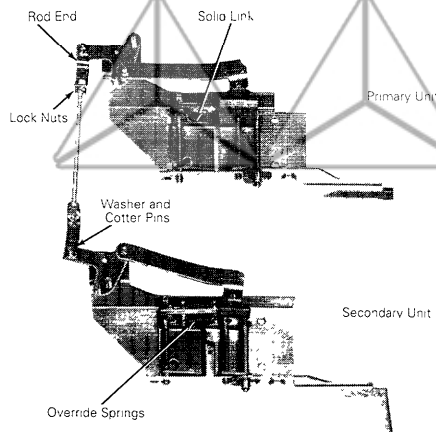

Figure 7. Attachment of the interconnection rod for a vertical installation.

Horizontal Interconnection

Use the following procedure to install the interconnect components between two breakers installed side by side.

1. Attach the long rod ends to the pins on the pivots as shown in Figure 8. A variety of connecting hardware is provided in the Mechanical Interlock kit; the $\frac{1}{4}$ -20 threaded rod is supplied by the customer.
2. Slip the provided heat-shrink tubing over the rod so that it provides insulation within the compartment through which the rod passes (right-side unit). Shrink the tubing in place with a hot air source of 100–300° C (212–572° F).
3. Adjust the length of the rod so that the pivot-to-pivot distance is equal to the center-to-center distance between the two compartments.

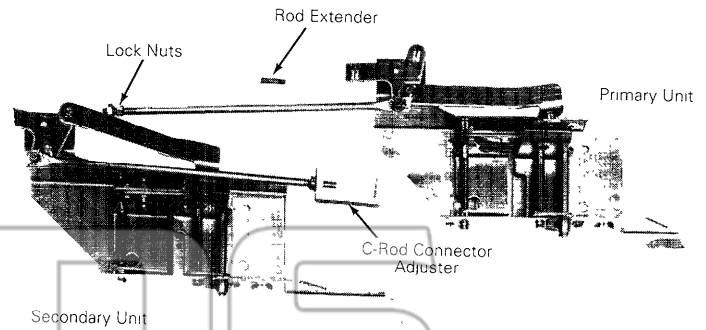

Figure 8. Attachment of the interconnection rod for a horizontal installation.

Installation Testing

Before installing the breakers, verify that the rod linkage is centered and free to move in either direction.

After installing the breakers, charge the closing springs on both breakers. Close one of the breakers, then attempt to close the other. The second breaker should immediately trip. Repeat the test with the breakers in the opposite order. If the second breaker does not trip in either case, check that the rod connecting the breakers is free to move in both directions when the breakers are sequenced from OFF to ON. If the rod is adjusted too short, one of the breakers will nuisance trip even when the other breaker is off. If the rod is adjusted too long, the interlock mechanism will not operate properly. A good length is one that eliminates the slack between the compartment linkages.

Trouble-Shooting

The following guide is provided for trouble-shooting and isolating common problems. It does not cover every possible situation. Contact the ED&C Customer Support Center at 800-843-3742 if any problem is not resolved by these procedures.

Symptom	Possible Cause	Corrective Action
1. The circuit breaker will not close and trips when an attempt is made to turn it ON.	The second breaker is turned ON.	Normal operation. The first breaker is prevented from closing when the second breaker is already ON.
	The rod that links the two compartments is adjusted too short.	Check the length of the connecting rod and verify that it is adjusted to the exact distance between the breakers. If the condition persists, lengthen the rod adjustment.
	The interlock unit is not correctly installed.	Verify that the rod linkage is centered and free to move in either direction when both circuit breakers are turned OFF.
2. Both circuit breakers can be turned ON at the same time.	The interlock was improperly installed or the plunger was not installed.	Verify that the breaker plunger is installed and that the knockout was removed without ragged burrs that would prevent the plunger from sliding freely in and out of the breaker when it is turned ON and OFF. The fork should move from left to right when the breaker is turned ON.
	The rod connecting the two breakers is not free to move.	Verify that the rod linkage is centered and free to move in either direction when both circuit breakers are turned OFF.
	The rod connecting the two breakers is adjusted too long.	Check the length of the connecting rod and verify that it is adjusted to the exact distance between the breakers. If the condition persists, shorten the rod adjustment.
3. The rod connecting the breaker compartments bends or buckles when either breaker is turned ON.	The primary and secondary devices are reversed, so that the interlock is operating in a "push" rather than a "pull" mode.	Reverse the installation of the primary and secondary units on the circuit breakers. Vertical interlock: primary unit on the top and secondary unit on the bottom; horizontal interlock: primary unit on the right and secondary unit on the left.

These instructions do not cover all details or variations in equipment nor do they provide for every possible contingency that may be met in connection with installation, operation, or maintenance. Should further information be desired or should particular problems arise that are not covered sufficiently for the purchaser's purposes, the matter should be referred to the GE Company.



GE Electrical Distribution & Control

General Electric Company
41 Woodford Ave., Plainville, CT 06062

GEH-6286 0496

© 1996 General Electric Company

Courtesy of store.ips.us