

Shunt Trip Kit for Manual DS/DSL Circuit Breakers
POWER ZONE® III Low Voltage Switchgear
Class 6035

INTRODUCTION

This bulletin contains instructions for adding a shunt trip assembly to a manual DS/DSL circuit breaker and modifying the POWER ZONE® III switchgear to accept a shunt trip circuit. Perform all steps as described to ensure safe installation and proper operation. If problems are experienced during installation, contact Square D Field Services Division at (800) 634-2003.

PRECAUTIONS

⚠ DANGER

HAZARD OF ELECTRIC SHOCK, BURN, OR EXPLOSION

- This equipment must be installed and serviced only by qualified electrical personnel (OSHA 1910.331-335).
- Turn off all power supplying this equipment before working on or inside equipment.
- Always use a properly rated voltage sensing device to confirm all power is off.
- Circuit breaker contacts must be open and all springs discharged before performing maintenance work.
- Replace all devices, doors, and covers before turning on power to this equipment.

Failure to observe these precautions will result in death, serious injury, or electric shock.

⚠ WARNING

HAZARD OF FALLING EQUIPMENT

- Never walk, stand, or work under a suspended load.
- Never walk, stand, or work under a circuit breaker resting on extended cradle arms.

Failure to observe these precautions can result in death, serious injury, or equipment damage.

INSTALLATION

Removing the Circuit Breaker

To remove the circuit breaker:

1. Open all load devices on the circuit and open the circuit breaker.

NOTE: When opening or closing the circuit breaker, refer to job requirements for operating key and electrical interlocks.

2. Disconnect the control power (internal and external).
3. Once the circuit breaker has been opened, rack it out to the disconnect position.
4. Pull out the cradle arms and withdraw the circuit breaker from the cell.
5. Remove the circuit breaker from the cradle arms by using the proper circuit breaker lifting devices. Refer to instruction bulletin 6035-1 for circuit breaker removal and installation procedures.
6. Place the circuit breaker on a secure, flat, level surface that can support a minimum of 450 lbs (205 kg).

Mounting the Shunt Trip

To mount the shunt trip:

1. Remove the screws on the circuit breaker face plate (Figure 1) and take the face plate off.



Figure 1: Location of faceplate screws

2. Locate the mounting holes in the left side circuit breaker frame. See Figure 2.

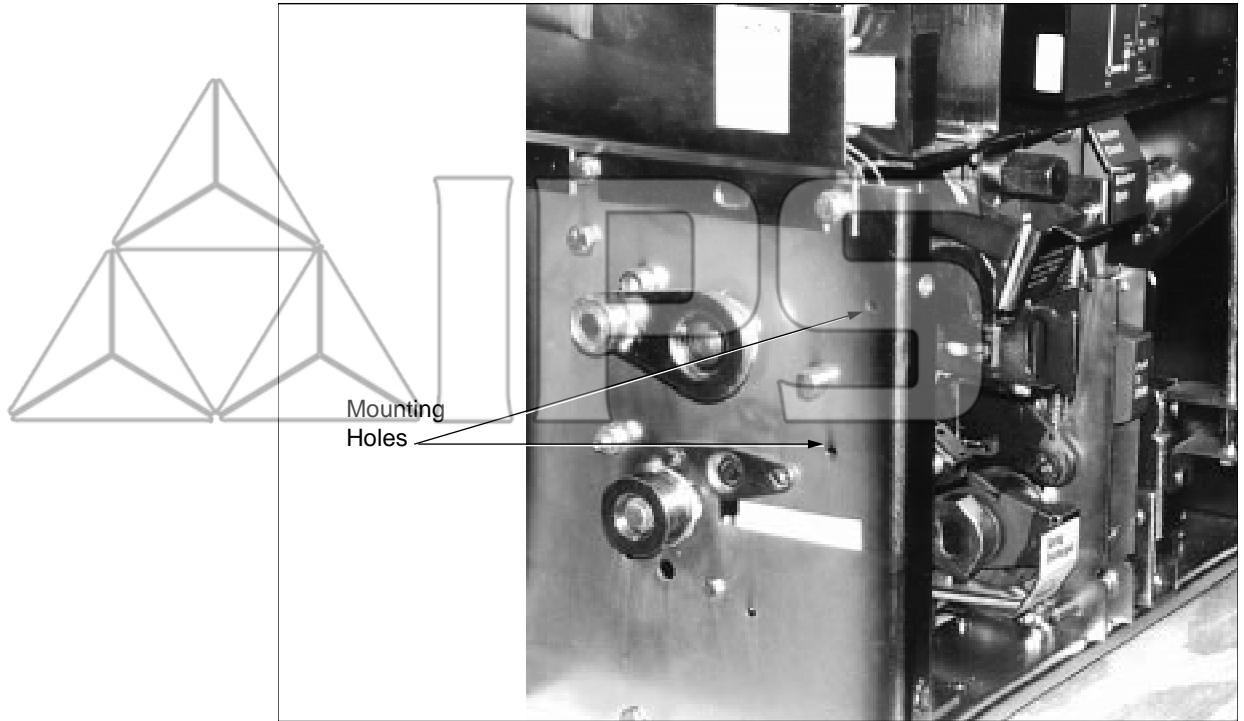

Figure 2: Location of mounting holes

3. Mount the shunt trip assembly (Figure 3) to the circuit breaker frame using the supplied screws.

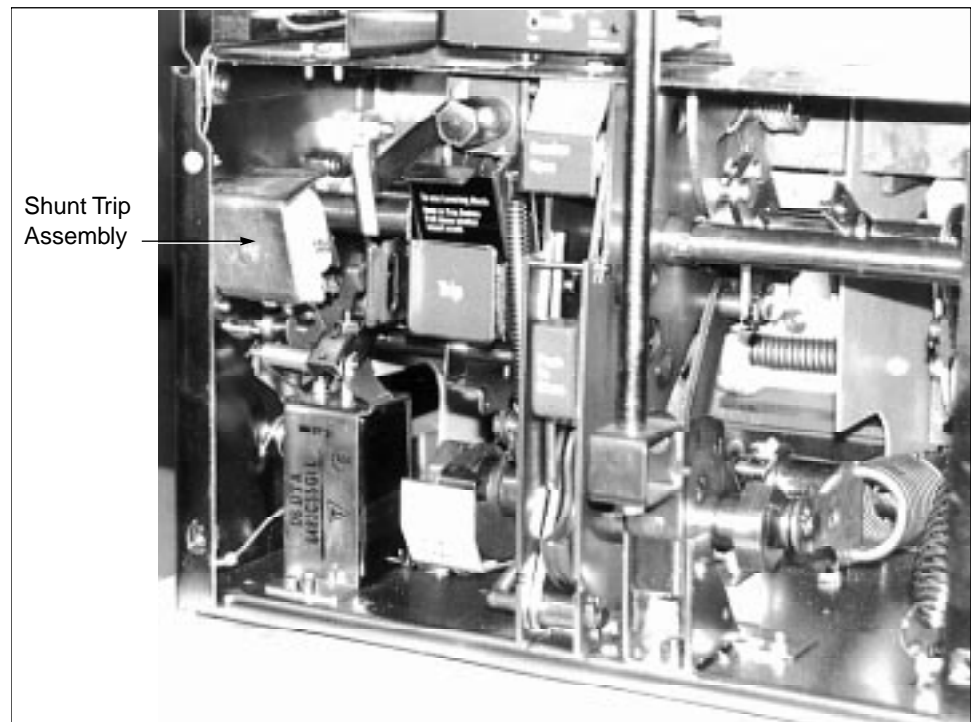

Figure 3: Position of shunt trip

Mounting the Auxiliary Switch

The auxiliary switch mounts on top of the circuit breaker. Facing the unit front and looking down on the unit top, the auxiliary switch mounts on the lower right as shown in Figure 4. If the circuit breaker is already equipped with an auxiliary switch, proceed to the next section, "Mounting the Moving Secondary Contact Frame."

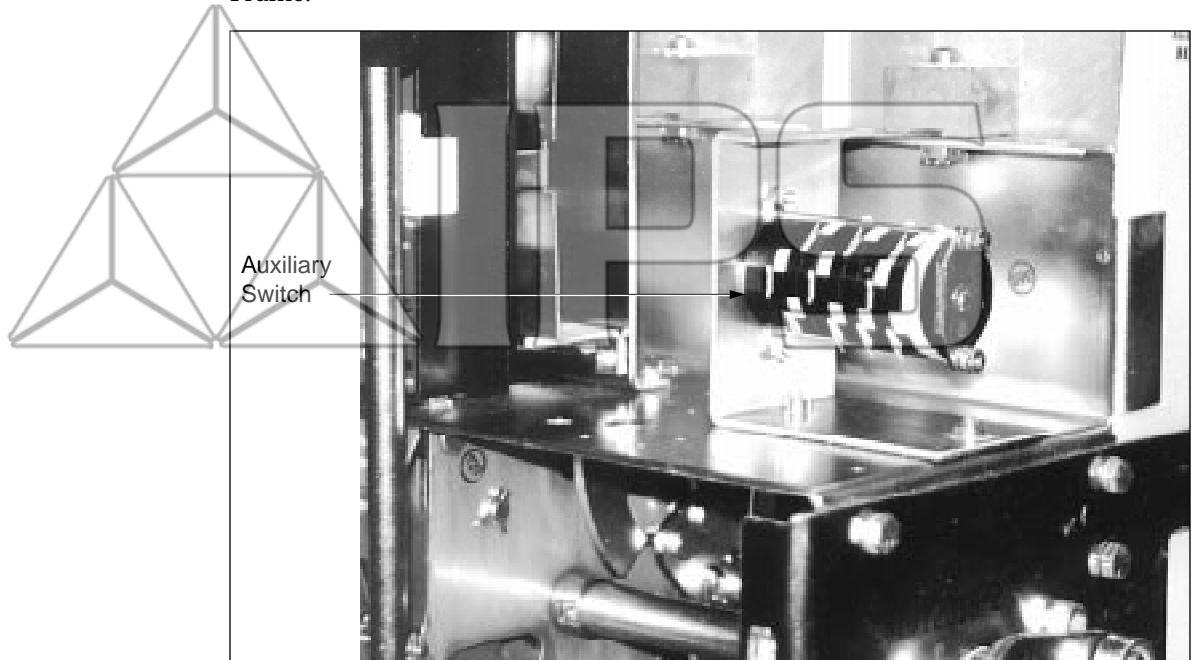

Figure 4: Position of the auxiliary switch

To mount the auxiliary switch:

1. Remove the auxiliary switch cover. See Figure 5.
2. Insert the linkage arm through the square hole on top of the circuit breaker.
3. Attach the auxiliary switch to the top of the circuit breaker using the supplied screws.
4. Attach the linkage arm to the pin located on the lever of the pole shaft. Secure the linkage to the pin using the x-ring provided. See Figure 6.

store.ips.us

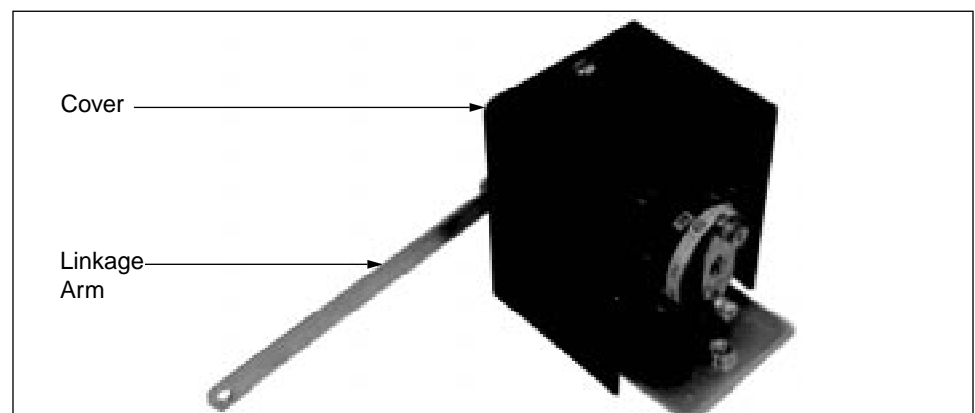

Figure 5: Removing the auxiliary switch cover

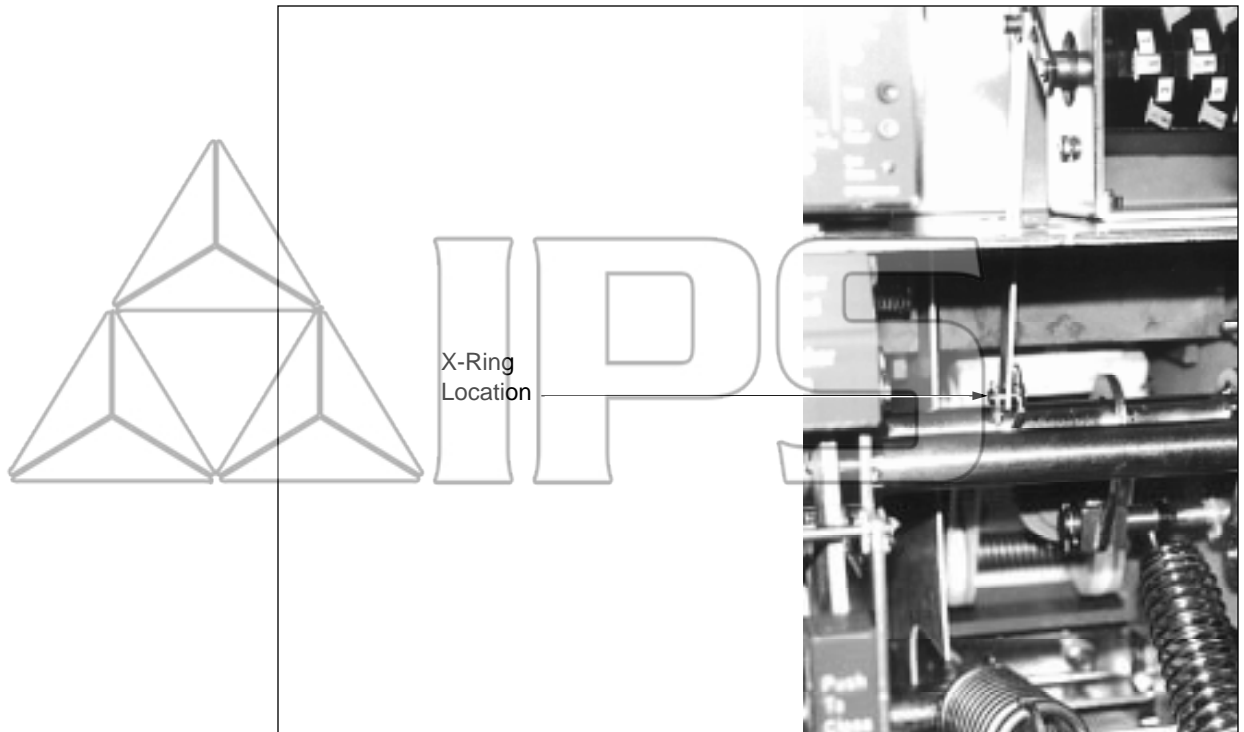

Figure 6: Auxiliary switch linkage arm

**Mounting the Moving
Secondary Contact Frame**

Refer to Figure 7 to determine if the circuit breaker is already equipped with a moving secondary contact frame. If so equipped, proceed to the next section, "Mounting the Moving Secondary Contacts."

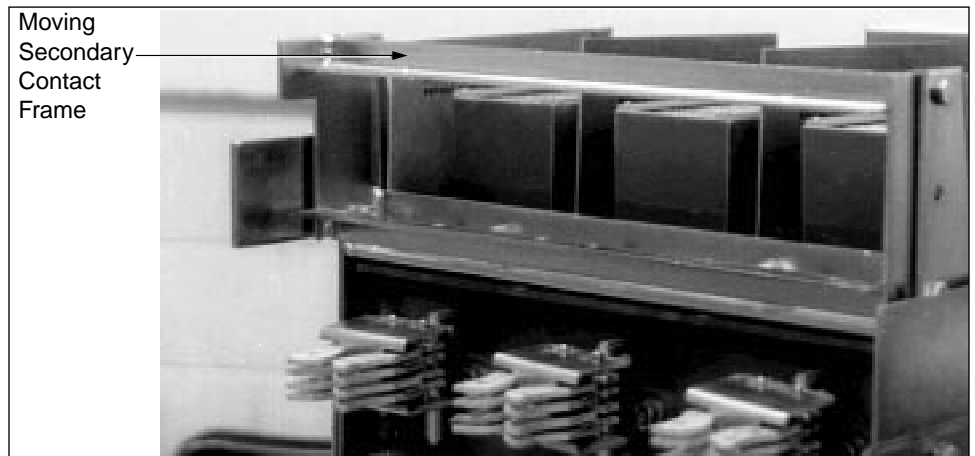

Figure 7: Secondary contact frame

If the circuit breaker is not equipped with a moving secondary contact frame, mount one as follows:

Mounting the Moving Secondary Contacts

store.ips.us

2. Mount the moving secondary contact frame with the supplied hardware as shown in Figure 7.
3. Replace the wiring tray on the left side of the circuit breaker frame. Ensure that wiring is not pinched between the wiring tray and the side of the circuit breaker.

Refer to Figure 9 to determine if the moving secondary contact block is present. If so, proceed to the next section, "Wiring the Shunt Trip and Auxiliary Switch." If the moving secondary contact block is not present, use the hardware provided to mount it to the circuit breaker in the upper left position (when viewed from the front of the circuit breaker). Refer to Figures 9 and 12.

NOTE: The moving secondary contact block may break if hardware is overtightened.

Figure 8: Wiring tray



1. Remove the wiring tray on the left side of the circuit breaker frame. See Figure 8.

Figure 9: Moving secondary contact block

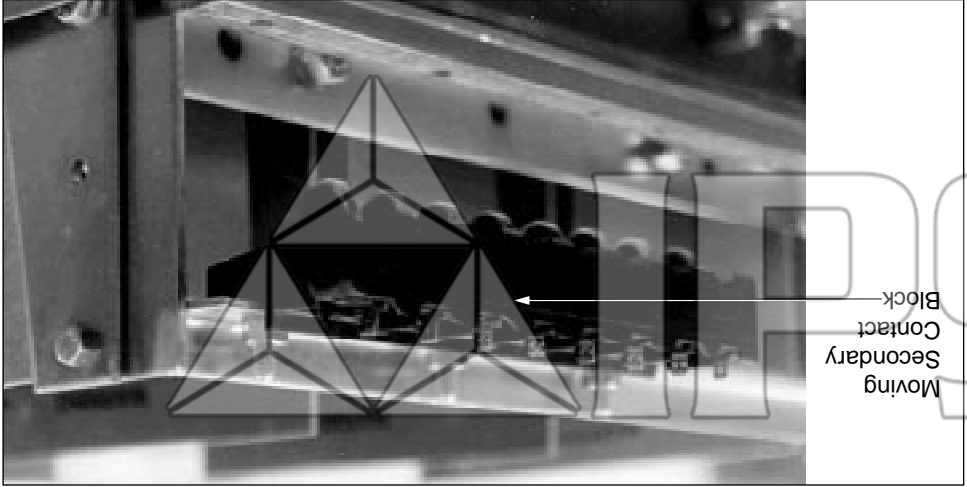

Wiring the Shunt Trip and Auxiliary Switch

- Using the wire provided, wire the shunt trip, auxiliary switch, and moving secondary fingers according to Figure 10.

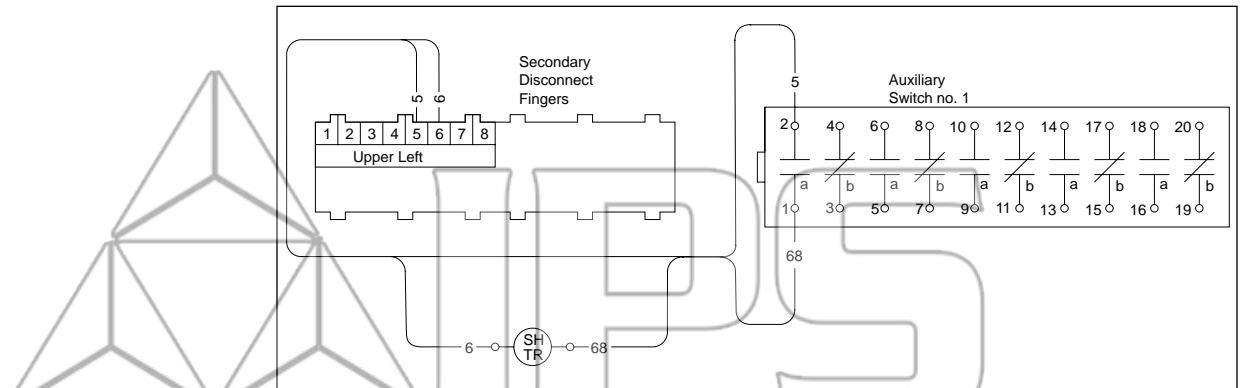

Figure 10: Wiring diagram for circuit breaker (front view of circuit breaker)

NOTE: If contacts 1 and 2 are being used, connect wires to any “a” contact on the auxiliary switch. The “a” contacts are open when the circuit breaker is open.

- Secure all wires with the cable ties included in the kit. Route wires from the moving secondary contacts along the left side of the circuit breaker (when viewed from the front). Place these wires into the wire tray on the side of the circuit breaker to secure them. Wires routed to the auxiliary switch should be routed behind the trip unit mounting bracket.
- Mount the moving secondary contact cover using the supplied hardware as shown in Figures 11 and 12.

NOTE: Glass polyester contact cover may break if hardware is overtightened.

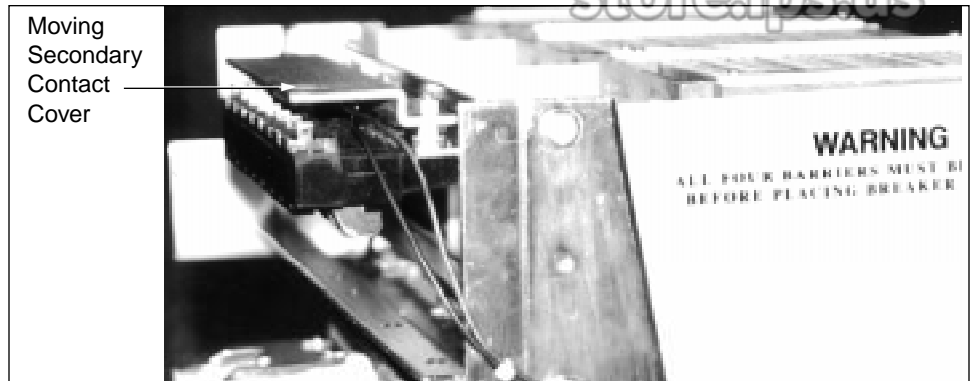

Figure 11: Moving secondary contact cover

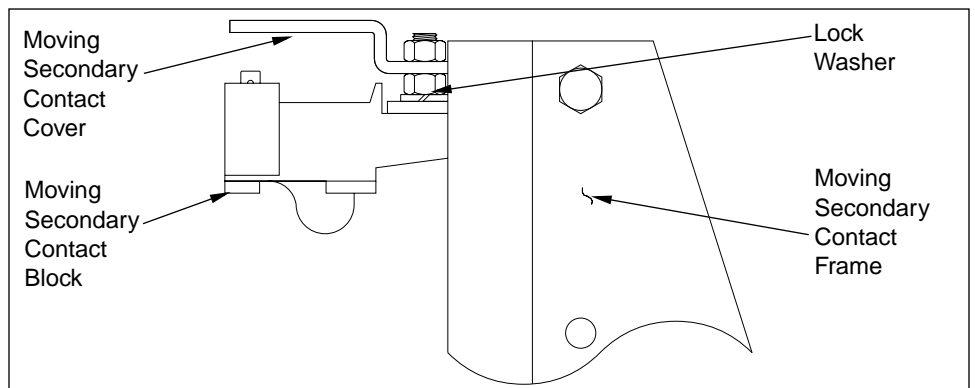

Figure 12: Moving secondary contact block and cover

4. Mount the auxiliary switch cover using the supplied hardware as shown in Figure 13.
5. Replace the circuit breaker face plate with the original screws.

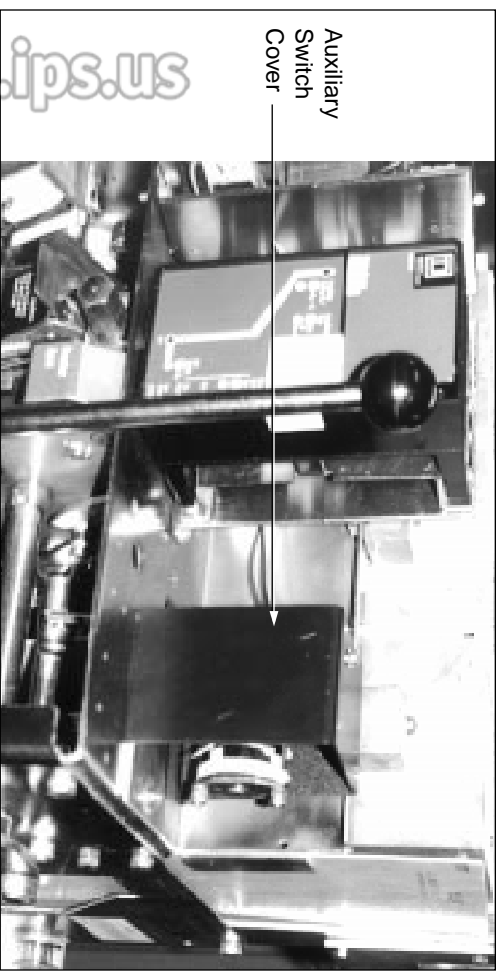

Figure 13: Auxiliary switch with cover

Mounting the Stationary Secondary Fingers

Refer to Figure 16 to determine if the stationary secondary mounting plate and fingers are in place. If they are present, go to step 4. If the stationary secondary fingers are not present, proceed as follows to mount them:

1. Determine which is the front side of the stationary secondary mounting plate by referring to Figure 14.

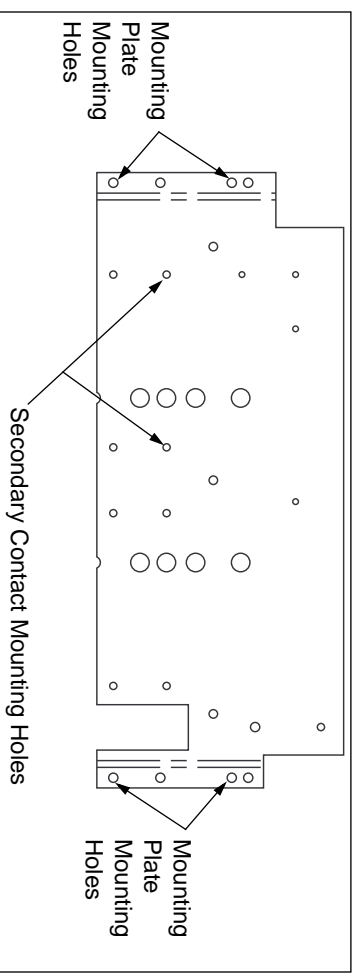

Figure 14: Stationary secondary mounting plate (front side)

2. Mount the stationary secondary contacts to the mounting plate holes using the hardware provided. Refer to Figure 15.

NOTE: If switchgear was manufactured before August 1992, the stationary secondary mounting plate is not needed. Mount stationary secondary contacts directly to the rear cell wall of the switchgear.

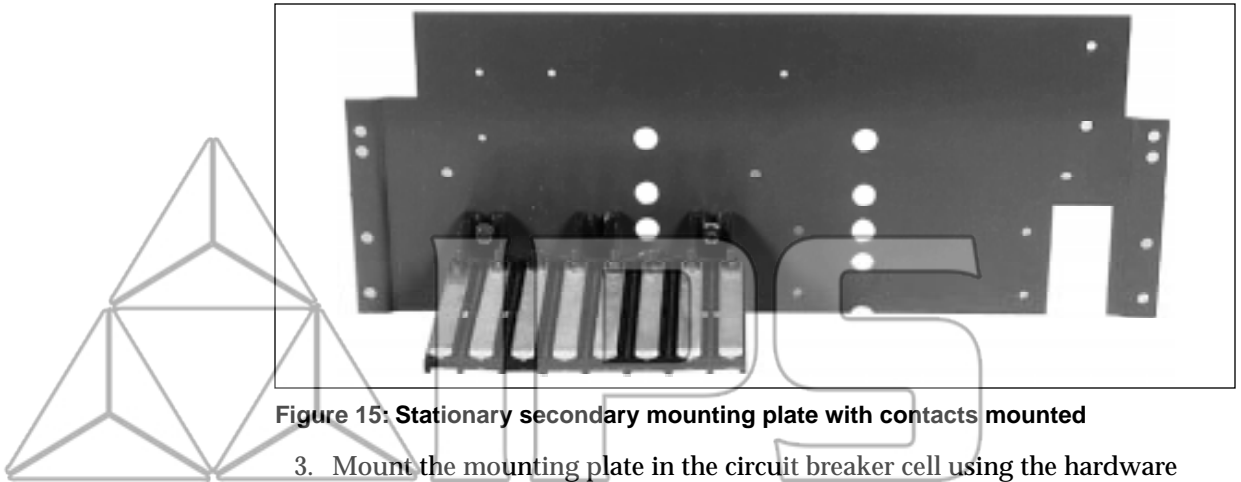

Figure 15: Stationary secondary mounting plate with contacts mounted

3. Mount the mounting plate in the circuit breaker cell using the hardware provided. Use the mounting holes indicated in Figure 14. Figure 16 depicts a stationary secondary contact properly mounted in a circuit breaker cell.

NOTE: Extra screws are required for 34 inch (865 mm) sections. Holes for these screws are indicated by "A" in Figure 17.



Figure 16: Stationary secondary contact mounted in the circuit breaker cell

4. Refer to revised Factory Order drawings included with the kit to wire the stationary secondary fingers and trip circuit.

NOTE: Use a proper wire crimping tool when terminating wires.

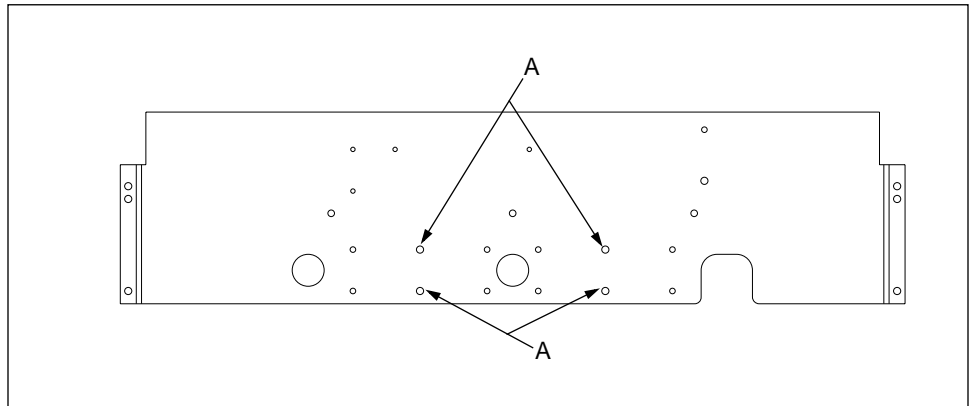

Figure 17: Screw holes for 34 inch (865 mm) sections

VERIFICATION



⚠ DANGER

HAZARD OF ELECTRIC SHOCK, BURN, OR EXPLOSION

- Verify that no tools or installation equipment is left inside the switchgear before turning on power to this equipment.
- Conduct electrical testing to ensure that no short circuits were created during installation.
- Replace all devices, doors, and covers before turning on power to this equipment.

Failure to observe these precautions will result in death, serious injury, or electric shock.

To verify that the shunt trip kit is installed correctly:

1. Install the circuit breaker into the test position only.
2. Manually close the circuit breaker.
3. Restore control power and energize the switchgear.
4. Use the external trip circuit for the shunt trip to verify that it opens the circuit breaker.
5. The circuit breaker can now be installed in the connect position and put back into service.

TROUBLESHOOTING

⚠ DANGER

HAZARD OF ELECTRIC SHOCK, BURN, OR EXPLOSION

- This equipment must be installed and serviced only by qualified electrical personnel (OSHA 1910.331-335).
- Turn off all power supplying this equipment before working on or inside equipment.
- Always use a properly rated voltage sensing device to confirm all power is off.
- Circuit breaker contacts must be open and all springs discharged before performing maintenance work.
- Replace all devices, doors, and covers before turning on power to this equipment.

Failure to observe these precautions will result in death, serious injury, or electric shock.

⚠ WARNING

HAZARD OF FALLING EQUIPMENT

- Never walk, stand, or work under a suspended load.
- Never walk, stand, or work under a circuit breaker resting on extended cradle arms.

Failure to observe these precautions can result in death, serious injury, or equipment damage.

If the circuit breaker does not function properly, perform these checks:

1. Verify that the shunt trip assembly and auxiliary switch are properly mounted.
2. Verify that secondary contacts are mounted in the correct positions.
3. Check all wiring. Verify that connections are complete and correct.
4. Check the external trip circuit to verify valid operation.

After performing these steps, repeat verification steps 1–5 as described above.



store.ips.us



store.ips.us

© 1997 Square D All Rights Reserved. This document may not be copied in whole or in part, or transferred to any other media without the written permission of Square D.

POWER ZONE, Square D, and  are Registered Trademarks of Square D Company.

Electrical equipment should be serviced only by qualified electrical maintenance personnel. No responsibility is assumed by Square D for any consequences arising out of the use of this material.

Square D Company
1500 S. University Blvd.
Middletown, OH 45044 USA

Bulletin No. 44027-017-01



SQUARE D

Printed in USA

Courtesy of store.ips.us